

液压油缸泵 (70MPa)

RIVERLAKE
ultra high pressure hydraulic tools www.riverlako.com

▼ HE 重载电动液压泵



最高输出压力: 70MPa

电机功率: 1.1KW-7.5KW

低压流量: 7-20L/Min

高压流量: 0.7-4.2L/Min

可用油容量: 10-200L

- IEC 无刷电机, 免维护
- 齿轮泵 + 径向柱塞泵两级泵结构, 高效率工作
- 电机泵头整体式设计, 重量轻
- 75dB 超低噪音
- 内置安全阀, 外置可调溢流阀
- 标配压力表、出口螺纹快速接头
- 标配可视油位计、加油口空滤、放油口堵头
- 标配泵上启停开关、电源插头线缆
- 可选配置: 线控手柄、油箱可锁紧脚轮、保护框架、风冷散热器、多路阀组、不同工作电压等

▼ HE 系列型号规格表:

规格	可选电压 (频率) (VAC/Hz)	电源相数	电机功率 (KW)	低压流量 (L/Min)	高压流量 (L/Min)
HE4	230 (50Hz) / 115 (60Hz)	1	1.1	7	0.7
HE5	230 (50Hz) / 115 (60Hz)	1	1.5	9	1
HE6	380/220	3	1.5	9	1
HE7	380/220	3	2.2	12	1.5
HE83	380/220V/440	3	3	12	1.8
HE84	380/660/440	3	4	12	2.3
HE95	380/660/440	3	5.5	20	3
HE97	380/660/440	3	7.5	20	4.2

▼ HE7040EVL43 产品示意图:

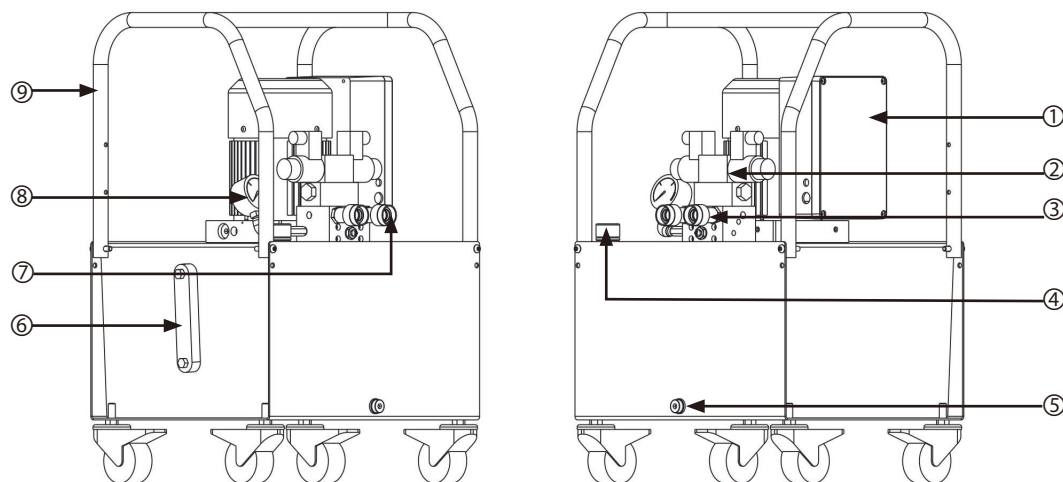

序号	名称
1	电控箱
2	电磁换向阀
3	快速接头
4	加油排气口
5	放油口
6	油位计
7	调压阀
8	压力表
9	保护框架

▼ HE 系列常用型号外形尺寸图:

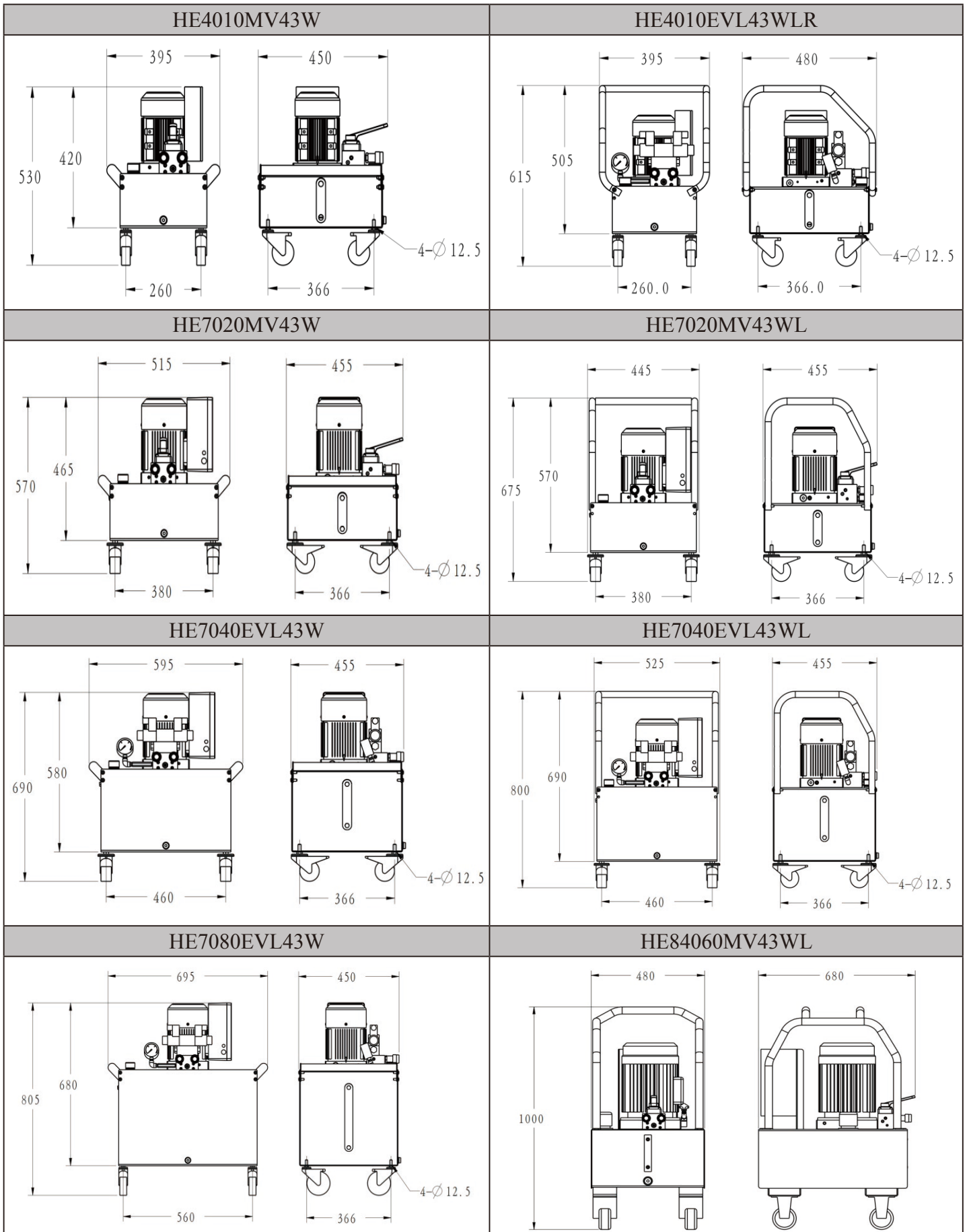

液压油缸泵 (70MPa)

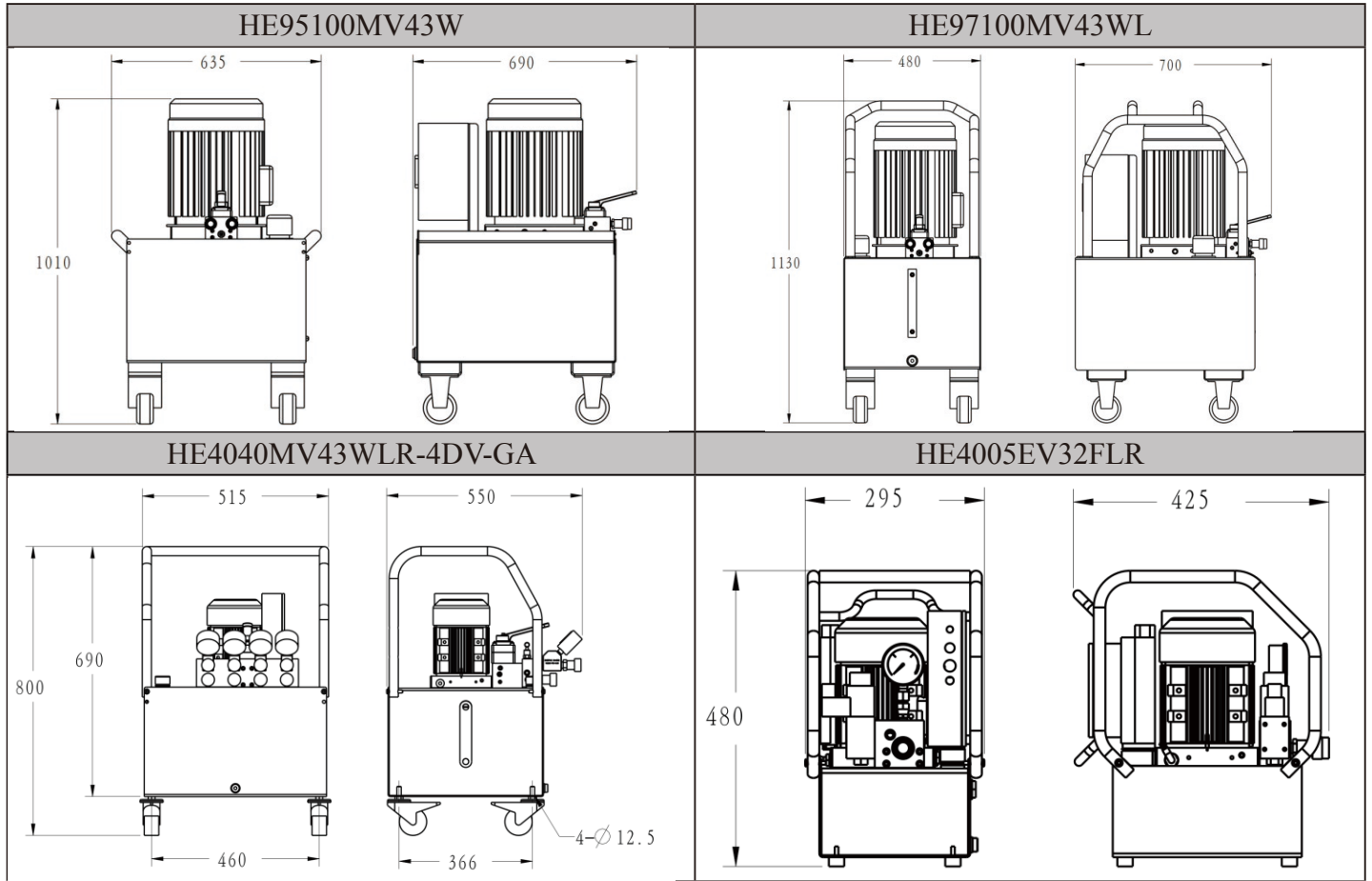

▼ 液压原理图:

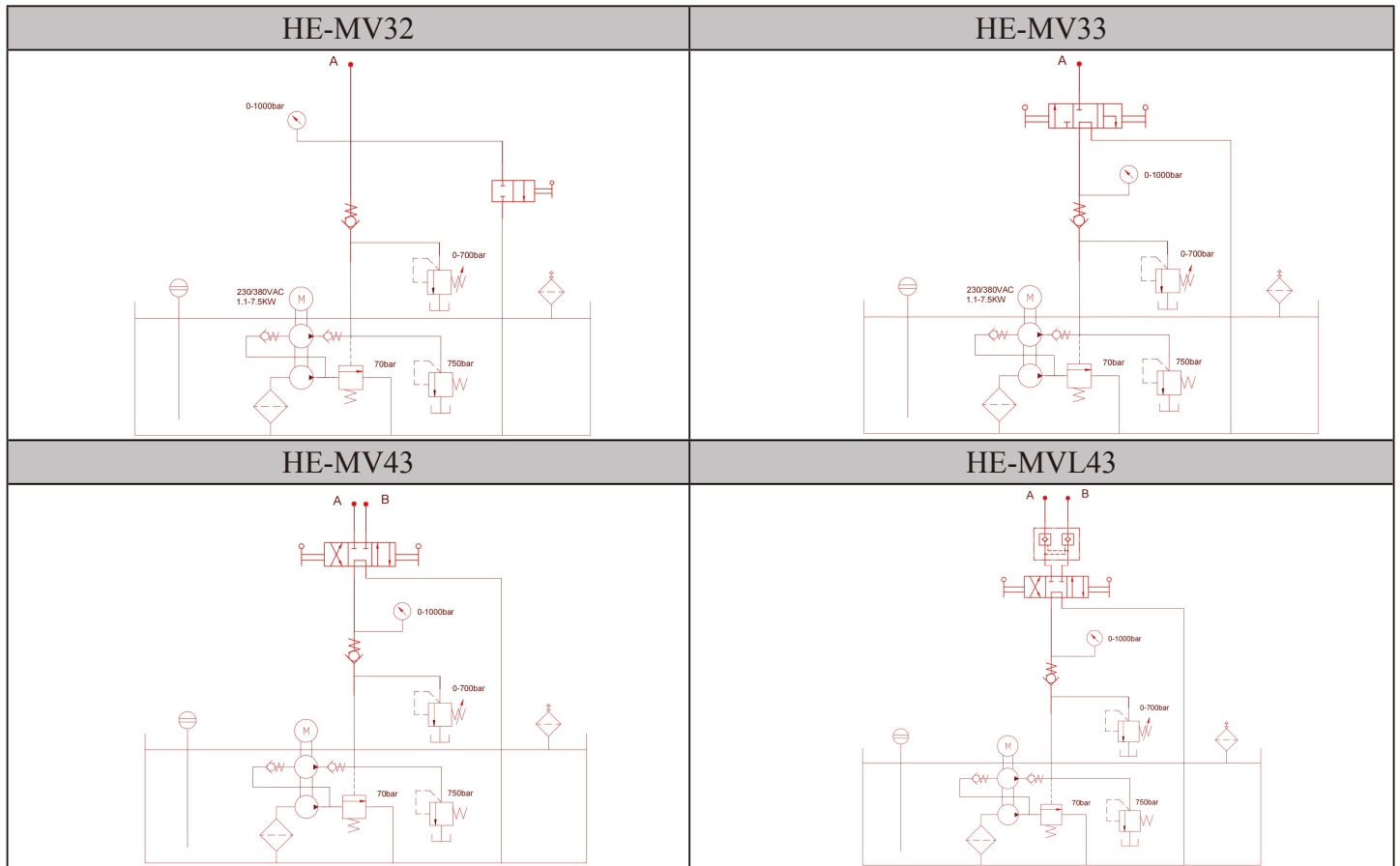

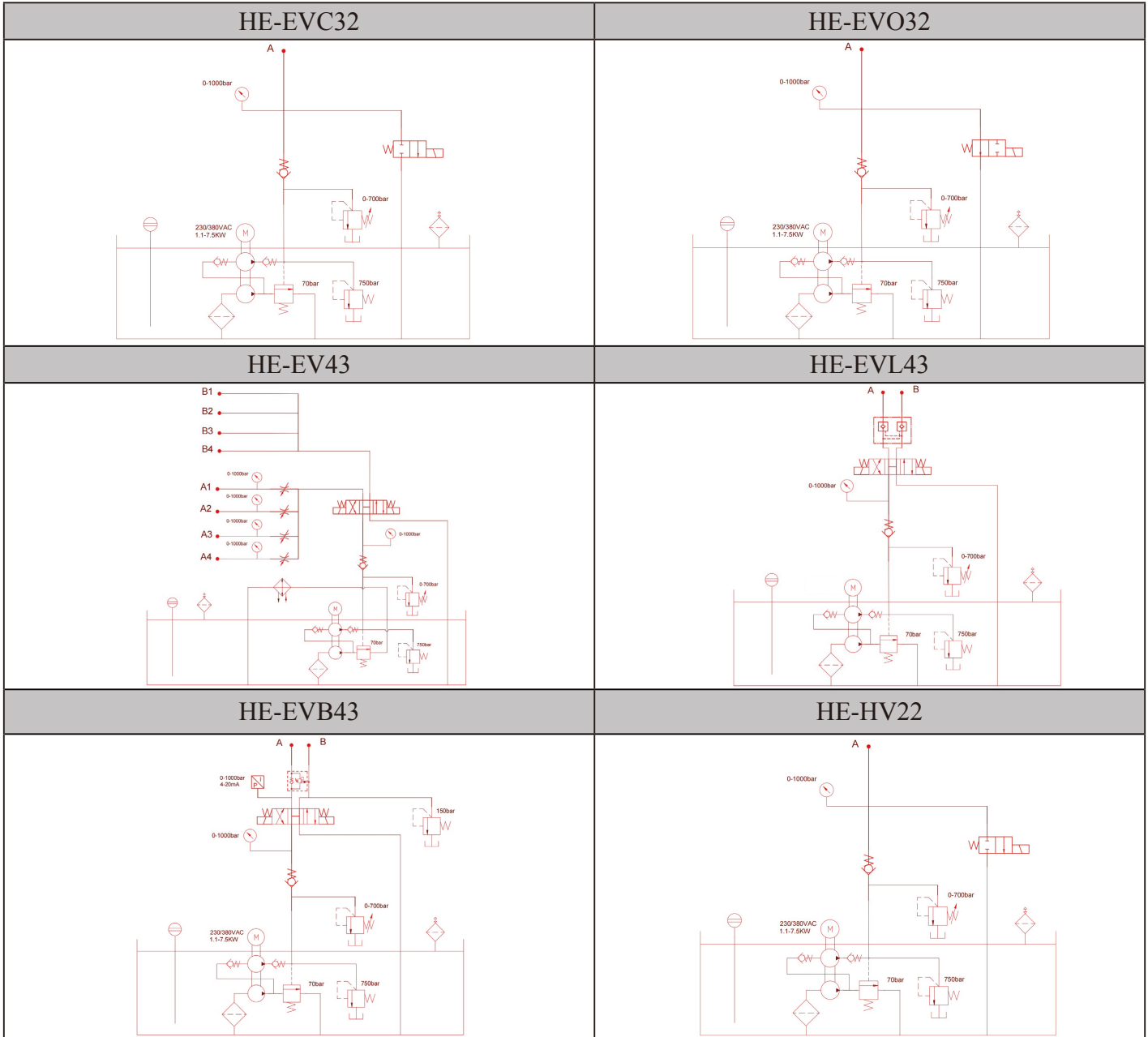

▼ HE 系列压力流量曲线:

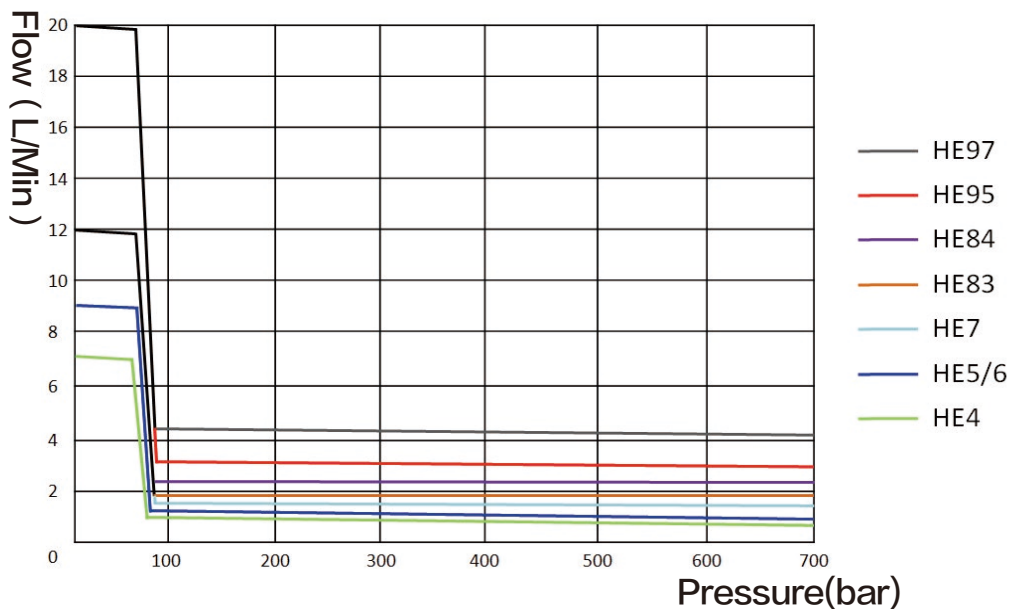

液压油缸泵 (70MPa)

▼ HE 系列选型表工具:

功率	油箱容量	阀门机能	脚轮	风冷散热器	保护框架	控制方式	多路阀	调压阀
HE4	•010	•MV32	▪ 空白 (无脚轮)	▪ 空白 (无风冷散热器)	▪ 空白 (标配搬运手柄)	▪ 空白 (配置泵上启停开关)	▪ 空白 (不含多路阀)	▪ 空白
HE4(115V)								
HE5	•020	•MV33	▪ W (配置可锁紧脚轮)	▪ F (配置散热器)	▪ L (全防护框架)	▪ R (线控手柄)	•2SV (2路单作用针阀)	▪ PRV1000
HE5(115V)							•2SV-2GA	
HE6	•040	•MV43	▪ W (配置可锁紧脚轮)	▪ F (配置散热器)	▪ L (全防护框架)	▪ R (线控手柄)	•2DV (2路双作用针阀)	▪ PRV1000
HE6(220V)							•2DV-2GA	
HE7	•060	•MVL43	▪ W (配置可锁紧脚轮)	▪ F (配置散热器)	▪ L (全防护框架)	▪ P (脚踏开关)	•4SV (4路单作用针阀)	▪ PRV1000
HE7(220V)							•4SV-4GA	
HE83	•080	•EVC32	▪ W (配置可锁紧脚轮)	▪ F (配置散热器)	▪ L (全防护框架)	▪ RC (数显手柄)	•4DV (4路双作用针阀)	▪ PRV1000
HE83(220V)							•4DV-4GA	
HE84	•100	•EVO32	▪ W (配置可锁紧脚轮)	▪ F (配置散热器)	▪ L (全防护框架)	▪ RC (数显手柄)	•6SV (6路单作用针阀)	▪ PRV1000
HE84(440V)							•6SV-6GA	
HE84	•200	•EV43	▪ W (配置可锁紧脚轮)	▪ F (配置散热器)	▪ L (全防护框架)	▪ RC (数显手柄)	•6DV (6路双作用针阀)	▪ PRV1000
HE84(440V)							•6DV-6GA	
HE84	•300	•EVL43	▪ W (配置可锁紧脚轮)	▪ F (配置散热器)	▪ L (全防护框架)	▪ RC (数显手柄)	•6DV (6路双作用针阀)	▪ PRV1000
HE84(660V)							•6DV-6GA	
HE95	•300	•EVB43	▪ W (配置可锁紧脚轮)	▪ F (配置散热器)	▪ L (全防护框架)	▪ RC (数显手柄)	•6DV (6路双作用针阀)	▪ PRV1000
HE95(440V)							•6DV-6GA	
HE95(660V)								
HE97								
HE97(440V)								
HE97(660V)								

◆ 选型举例: HE4080MV43WFLR-4DV、HE84 (440V) 100MV43WF-RC-4DV

◆ 油箱容量为最大可用油容量, 单位 L

◆ 阀组机能请参见阀组机能表格

◆ 多种其他非标定制方式可选, 例如多路电磁阀阀组、多路手动换向阀组、脚踏开关、定制油箱容量外形、压力传感器、压力开关、压力表、定制电气控制、不同外观颜色等









◆ 以上命名方式不代表全部供货范围, 更多选择请详情咨询

▼ HE 系列选型介绍:

▼ 功率电压对应表

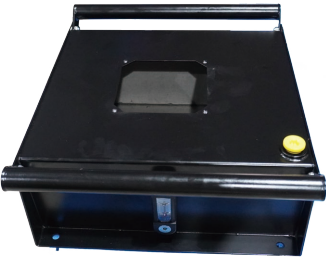

名称	属性
HE4	1.1KW,1PH,230VAC/50HZ
HE4(115V)	1.1KW,1PH,115VAC/60HZ
HE5	1.5KW,1PH,230VAC/50HZ
HE5(115V)	1.5KW,1PH,115VAC/60HZ
HE6	1.5KW,3PH,380VAC
HE6(220V)	1.5KW,3PH,220VAC
HE7	2.2KW,3PH,380VAC
HE7(220V)	2.2KW,3PH,220VAC
HE83	3KW,3PH,380VAC
HE83(220V)	3KW,3PH,220VAC
HE83(440V)	3KW,3PH,440VAC
HE84	4KW,3PH,380VAC
HE84(440V)	4KW,3PH,440VAC
HE84(660V)	4KW,3PH,660VAC
HE95	5.5KW,3PH,380VAC
HE95(440V)	5.5KW,3PH,440VAC
HE95(660V)	5.5KW,3PH,660VAC
HE97	7.5KW,3PH,380VAC
HE97(440V)	7.5KW,3PH,440VAC
HE97(660V)	7.5KW,3PH,660VAC

▼ 油箱容量、框架及脚轮选择





-10WL	-20W	-20WL	-40
			
-20	-40W	-40WL	-60W
			

◆ 以上展示图不代表全部供货范围，更多选择请详情咨询









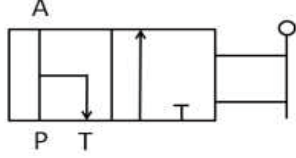
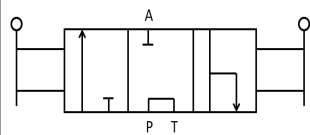

▼ 风冷散热器

-F (220V)	-F (380V)
	

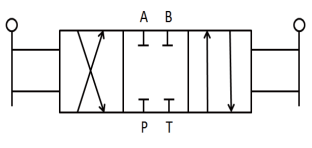
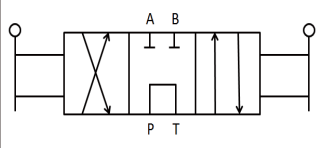

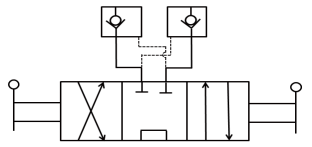
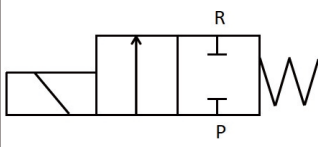
▼ 控制方式

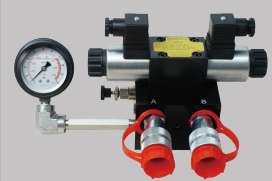
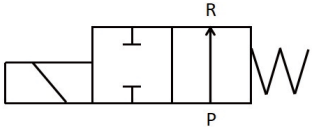
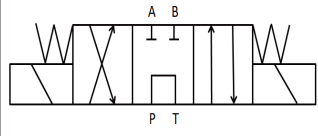
-R 单按钮手柄	-R 双按钮手柄
	
-R 三按钮手柄	-RC 数显手柄
	

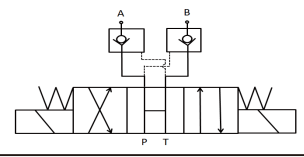
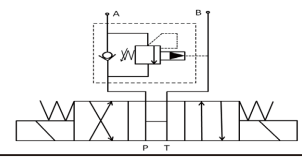
液压油缸泵 (70MPa)

名称	图片	泵阀机能组合	名称	图片	泵阀机能组合
MV32		手动控制 单回路 前进 / 保压 / 后退 零泄漏	MV33		手动控制 单回路 前进 / 保压 / 后退 微泄漏
					
MV43-O		手动控制 双回路 前进 / 保压 / 后退 微泄漏	MV43-M		手动控制 双回路 前进 / 保压 / 后退 微泄漏
					
MV43L		手动控制 双回路 前进 / 保压 / 后退 零泄漏 带负载保持阀	EVC32		电磁阀控制 单回路 前进 / 保压 / 后退 微泄漏
					
EVO32		电磁阀控制 单回路 前进 / 后退	EV43-M		电磁阀控制 双回路 前进 / 保压 / 后退 微泄漏
					
EVL43		电磁阀控制 双回路 前进 / 保压 / 后退 零泄漏 带液压锁	EVB43		电磁阀控制 双回路 前进 / 保压 / 后退 零泄漏 带负载平衡阀
					

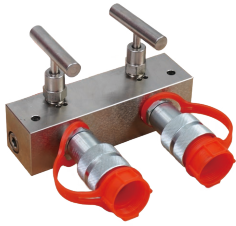
▼ 多路阀选择

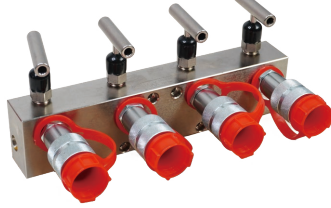
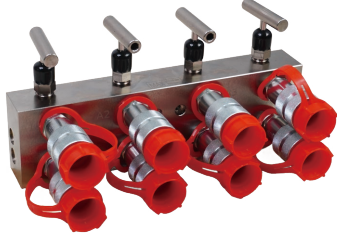
2SV	2DV	4SV	4DV
			

▼ PRV 精密调压阀



▼ HE 系列常用型号举例:

HE4010MV32-PRV 	HE4010MV43 	HE4010MV43R 	HE7040EVL43LR 
HE6040EVL43R 	HE5010MV43W 	HE4010EVL43WFLR 	HE84040EVL43WR 

液压油缸泵 (70MPa)

RIVERLAKE
ultra high pressure hydraulic tools www.riverlactco.com

HE7040MV43W-4DV	HE83080MV43WL	HE4010MV32-2SV-PRV	HE4010MV32-4SV-PRV
			
HE5010MV43R-2DV	HE4010MV43WFLR-2DV	HE4040EVL43RLF	HE5040MV32-10SV-PRV
			
HE4010MV33-6SV	HE84080MV33WL-4SV	HE7040MV43W-4DV	HE4010MV43(2)
			
HE5010EVL43(4)RL	HE4010EVL43(2)R	HE4007EVO32WFLP	HE83040EVO32WLP
			

HE4005EVL43FLR	HE7(2)080EVB43-2R	HE4010MV43R-2SV-115/60	HE4005MV32L
			
HE6020EVL43R	HE97100MV43(2)WL	HE95080MV43-2-WLR	HE97150MV43WLR
			
HE7080MV43W-4DV-4GA	HE97080MV43(2)WL	HE97080MV43(2)WL	HE97150MV43WLR-PRV
			
HE97080EVB43RW	HE7020MV33LR-4SV	HE84040MV33WL-4SV-PRV	HE97300MV43W
			